

AUSTIN FREESTANDING

DATA SHEET COMPACT AND VERSATILE

Sleek, modern, and built for almost any environment.

The Austin continues Olea's mission to redefine self-service. Rather than create a rigid solution, the Austin was meticulously engineered to be the most flexible solution in the kiosk market.

Enjoy access to hundreds of existing configurations to make each Austin your own. Dress it up with custom graphics or keep it simple and elegant, the choice is yours. Its compact footprint and rugged security complement a variety of environments for companies that seek to improve ROI and user interaction in small spaces or high traffic areas.

BRINGING EXCELLENCE TO THE GUEST EXPERIENCE

- Food ordering
- Ticketing
- Information
- Check-in / Check-out
- Wayfinding
- Virtual receptionist
- Retail transaction
- Bill payment



AUSTIN FREESTANDING KIOSK

SLEEK, FRIENDLY. AN INTERACTIVE DIGITAL DISPLAY THAT WILL IMPRESS YOUR GUESTS AS MUCH AS IT HELPS THEM.



The Austin Freestanding Kiosk is the product of 40+ years of feedback and over one hundred million customer interactions. Gone are the days of a single monitor option, a single printer option, or other strict design rules.



The monitor can be ordered in portrait or landscape orientation. Both 15" and 22" PCAP touchscreens are available.

- The kiosk is serviced from the front side, making it easy to get in-and-out quickly when routine maintenance is needed.
- The kiosk utilizes familiar POS receipt printers so that no kiosk-specific receipt paper needs to be ordered and stocked.
- Several payment device options are already available and more are added as needed.

With so many existing configurations, the Austin is used for food ordering, ticketing, healthcare check-in, and more.



A CLOSER LOOK

AT AUSTIN FREESTANDING

STANDARD SPECS

- 5" or 22" All in One Computer
- Projective capacitive multi-touch touch sensor
- Durable powder coat paint finish
- 16 Gauge Galvanized Steel
- Security Locks
- Internal 6-outlet power strip w/ surge protection
- Topple resistant base plate with ability to bolt to ground

DIMENSIONS

Landscape Dimensions

- Width: 24.08"
- Height: 52.95"
- Depth: 20.63"
- Base plate: 21"w x 20.63"D

Portrait Dimensions

- Width: 16.21"
- Height: 54.89"
- Depth: 20.63"
- Base plate: 21"w x 20.63"D

OPTIONAL COMPONENTS

- 15" or 22" All in One Multi-Touch Computer (PCAP)
- Ingenico and Verifone payment devices
- Epson TM-t88VI receipt printer
- Star Micronics TSP650II
- Barcode Scanner 1D, 2D, PDF, and QR
- ID Card / loyalty / gift card scanner
- Room key dispenser

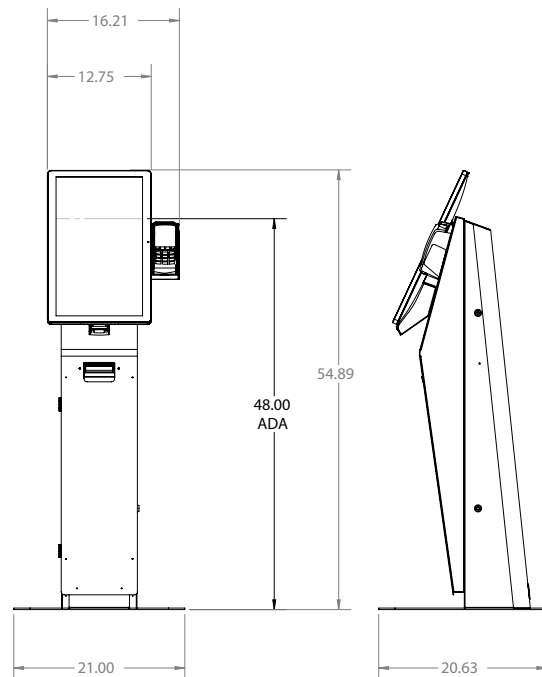
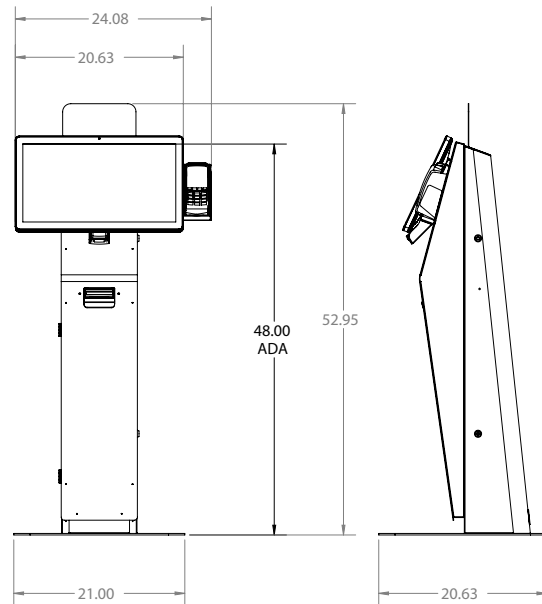

REDEFINING SELF-SERVICE TECHNOLOGY

ABOUT OLEA KIOSKS

CONTINUING A PROUD HERITAGE OF EXCELLENCE

Inspired by a true passion for his craft, master carpenter Fernando Olea began a tradition of bringing his customers' ideas to life back in 1975. He started designing, engineering and producing furniture, cabinetry, display exhibits, commissioned works of art and, later, kiosks in his small, rented RV garage in Downey, California. And Olea was born.

From those humble beginnings to the company's current high-capacity manufacturing facility in Southern California, Olea Kiosks continues to be driven by our founder's innovative spirit, with an old-fashioned commitment to quality, craftsmanship, and service. More than 40 years later our network of 35,000 kiosks registers over 100 million touchpoints per year and we remain a family-owned and operated company. Olea continues to push the limits of kiosk design, using our curiosity and intuition to find new self-service solutions that create a lasting impact for our customers.

AN UNPARALLELED COMMITMENT TO QUALITY AND SERVICE

At Olea, we go beyond producing kiosks that simply meet your technical requirements. We engineer self-service solutions that enhance our clients' brands and complement any space where they are implemented. The following in-house departments work together to consistently deliver attentive customer service and innovative kiosks that comply with our strict quality control guidelines.

- Consulting
- Industrial Design
- Creative Consulting and Graphic Creation
- Mechanical and Structural Engineering
- OEM Manufacturing
- Integration Services
- IT Department (for product testing, computer ghosting services and hardware selection/consulting)
- Powder Coat Painting
- Certification Services
- Patent Services

